

## LED Roadway Lighting Luminaire SPECIFICATION (4000K@120-277V)

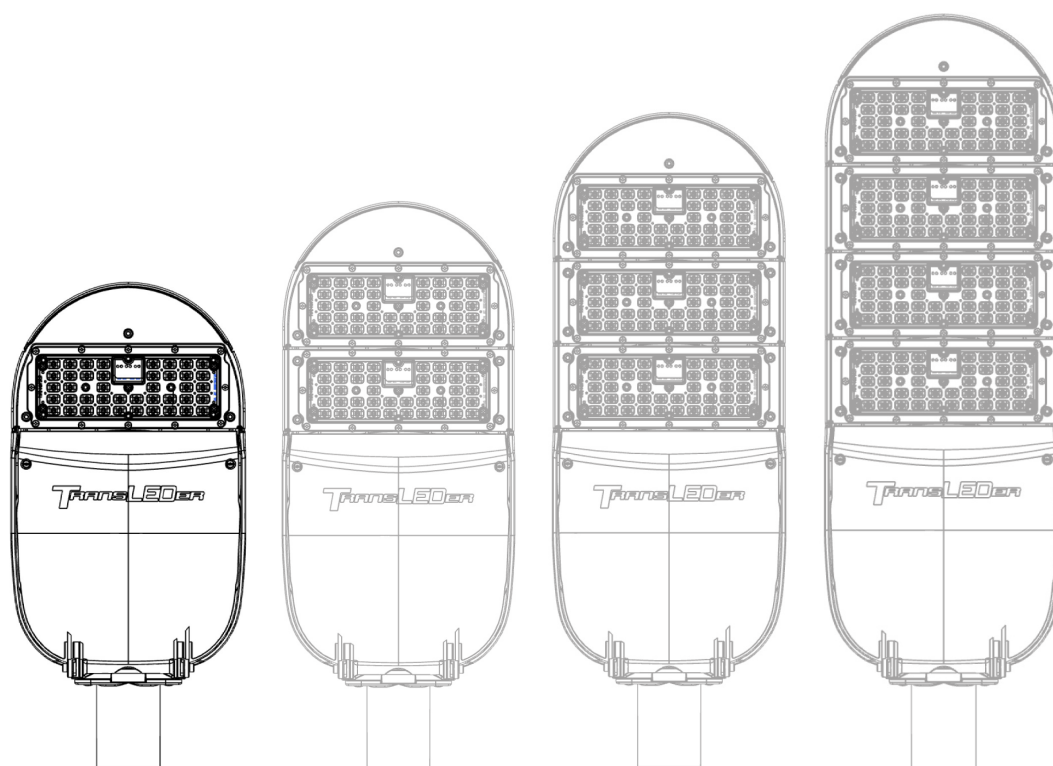

## ORDER GUIDE

Group	TL	UUU	VV	WW	XX	Y	ZZ
Example	RL	110	5M	NW	UL	D	BZ

Group	Description
RL	Represents LED <b>Roadway Lighting</b> ;
UUU	Represents input power, which can be 040, 070, 100, 110, 190, 210, 265, 335 or others, e.g., 110= <b>110 W</b> ;
VV	Represents lens type, distinguished by different models, which can be 2M, 3M, 4M, 4S, 5M, 5S, or others.  Type II (Full Cutoff)    2S (Short); <b>2M (Medium)*</b> ;    2L (Long); Type III (Full Cutoff)    3S (Short); <b>3M (Medium)*</b> ;    3L (Long); Type IV (Full Cutoff)    4S (Short); <b>4M (Medium)*</b> ;    4L (Long); Type VS (Full Cutoff)    5S (Short); <b>5M (Medium)*</b> ;    5L (Long).
WW	Represents the nominal Correlated Color Temperature, which can be  CW                            Cool White    5000 K (± 300 K); <b>NW</b> <b>Neutral White</b> <b>4000 K (± 300 K)*</b> ; WW                            Warm White    3000 K (± 300 K)*;
XX	Represents the input voltage: <b>UL (120-277V)*</b> , or UH (480V).
Y	Represents the dimming function, <b>D (DALI)*</b> , or P (Photocell).
ZZ	Represents the luminaire body color, which can be BK, BZ, GN, GY or WT  BK                            Black            (RAL 9017); <b>BZ</b> <b>Bronze</b> <b>(RAL 8019)*</b> ; GN                            Green            (RAL 6005); GY                            Gray            (RAL 7038); WT                            White            (RAL 9010).

\* Featured products.

+ Warm-toned LED light sources (3000K or lower) must be selected to meet the International Dark-Sky Association dark sky requirements.

## CERTIFICATIONS

SAFETY	Luminaires [UL 1598:2021 Ed.5]	Certified
SAFETY	Luminaires [CSA C22.2 No. 250.0:2021 Ed.5]	Certified
FCC	FCC Part 15 Subpart B; ANSI C63.4a-2017	Certified
DIELECTRIC WITHSTAND AND ELECTRICAL TRANSIENT IMMUNITY	C136.2-2015: Clause 6, Clause 7, 7.1, 7.2, 7.3, 7.4	Certified
INGRESS PROTECTION	Ingress protection	IP65
THD	Max. Total Harmonic Distortion (%)	20
IMPACT TEST	Resistance to external mechanical impact test	IK10
SALINE MIST TEST	Salt spray test to ISO 9227	1,000 hours
RoHS COMPLIANCE	European Directive 2011/65/EC	Certified

**SPECIFICATION**

RL-110-VV-NW-UL-D-BZ (One-Module)

VOLTAGE	Nominal luminaire input voltage range	120-277 V
INPUT POWER	Nominal luminaire input power	110.0 W ‡
LUMINAIRE OUTPUT	Nominal luminaire luminous flux output	14200 lm ‡
EFFICACY	Nominal luminaire efficacy	129.1 lm/W ‡
POWER FACTOR	Min. power factor	0.99‡
LUMEN MAINTENANCE	Min. % of the initial output at 100,000 hours operation	L95.6
• L90	Estimated time reaching 90% of the initial luminous flux	> 102,000 hours
• L80	Estimated time reaching 80% of the initial luminous flux	> 102,000 hours
• L70	Estimated time reaching 70% of the initial luminous flux	> 102,000 hours
LMF	Luminaire maintenance factor used for simulation	0.80
CHROMATICITY SHIFT	LED chromaticity shift at 7,000 hours operation	0.0015 Δu'v'
NOMINAL CCT	Nominal correlated color temperature	4000 K
CRI	Color Rendering Index	> 70
WEIGHT	Max. luminaire weight	15.3 lbs.
DIMENSION	L x W x H	24.3" x 11.7" x 5.8"
SAIL AREA	Max. effective sail area	0.59 ft <sup>2</sup>
TERMINAL BLOCK GAUGE	6-Way Screw Down Terminal Blocks Wire Gauges	#14 AWG - #6 AWG
PCR	Photoelectric Control Receptacle	Rotatable
OPTICAL DISTRIBUTION	<input type="checkbox"/> Type II <input checked="" type="checkbox"/> Type III <input checked="" type="checkbox"/> Type IV <input checked="" type="checkbox"/> Type V	
MOUNTING SLIP FITTER	<input checked="" type="checkbox"/> Top-entry <input checked="" type="checkbox"/> Side-entry <input checked="" type="checkbox"/> Integral tilt (-10° to +10°)	
	Nominal Pole Size (NPS)	1.25"/2" NPS
VIBRATION	ANSI C136.31 <input type="checkbox"/> Level 1 (normal) <input checked="" type="checkbox"/> Level 2 (bridge/overpass)	
THERMAL ENVIRONMENT	Typical min. ambient temperature during operation	-40 °C (-40 °F)
	Typical max. ambient temperature during operation	+40 °C (+104 °F)
SURGE PROTECTION DEVICE	ANSI C136.2 <input type="checkbox"/> Basic (6kV/3kA) <input checked="" type="checkbox"/> Enhanced (10kV/5kA) <input type="checkbox"/> Elevated, (20kV/10kA)	
CONTROL INTERFACE	<input type="checkbox"/> None <input type="checkbox"/> ANSI C136.10 3-pin <input type="checkbox"/> ANSI C136.41 5-pin <input checked="" type="checkbox"/> ANSI C136.41 7-pin	
LED DRIVER	<input type="checkbox"/> Not Dimmable <input type="checkbox"/> Dimmable, 0-10V (IEC 60929) <input checked="" type="checkbox"/> Dimmable DALI-2, D4i, NFC	

‡ Values shown are subject to ±5% tolerance.

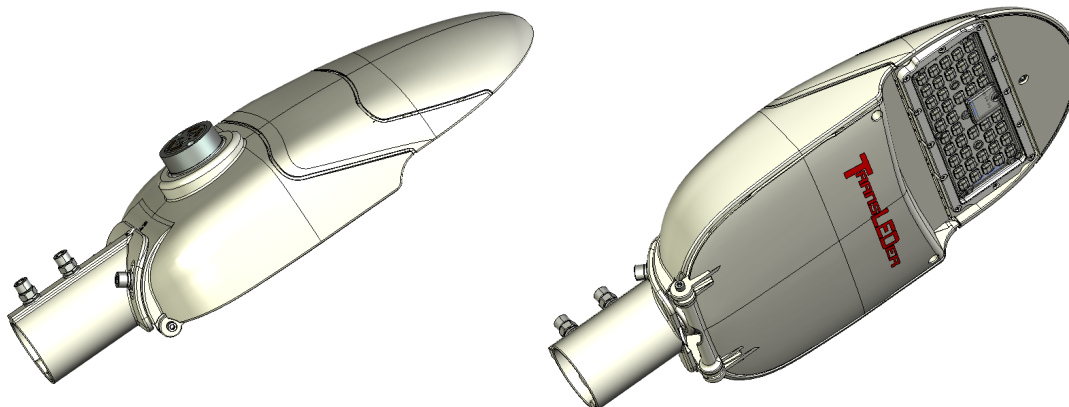

**PHOTOMETRY**

**Type III Medium Full Cutoff**

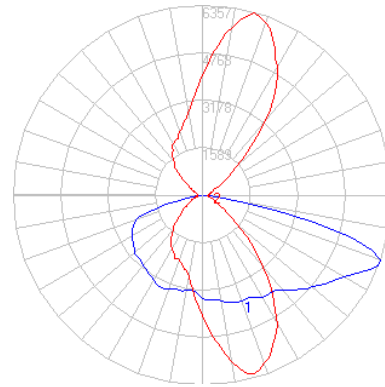
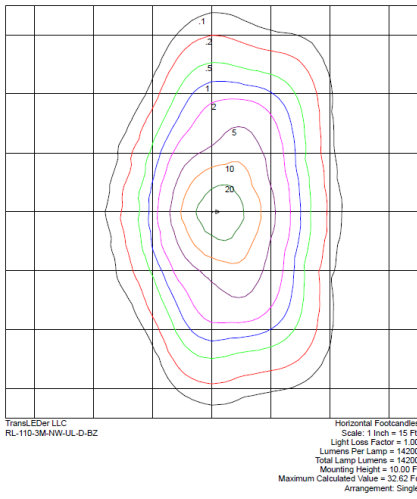

**Type IV Medium Full Cutoff**

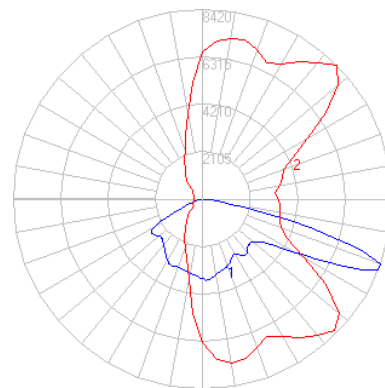
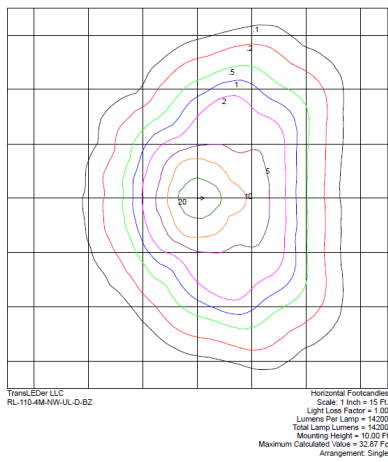

**Type V Medium Full Cutoff**

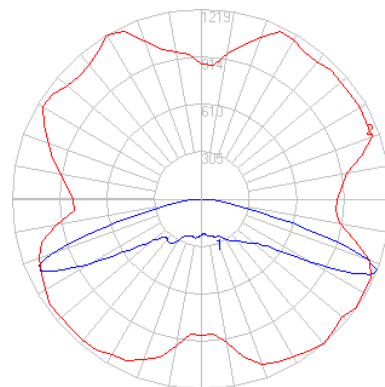
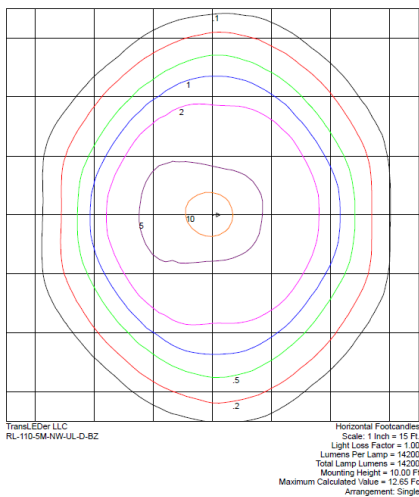

**DIMENSIONS**

1-Module Model

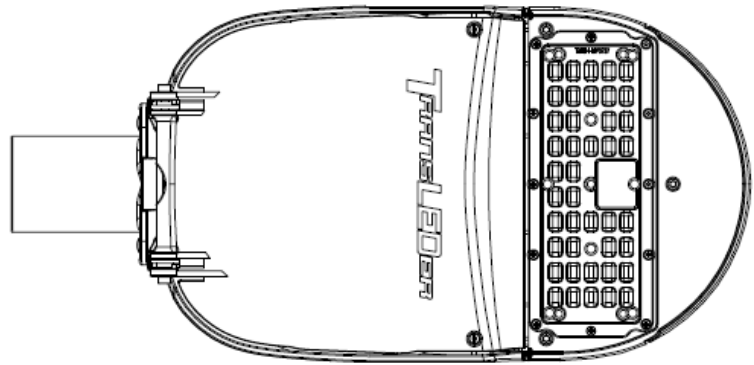
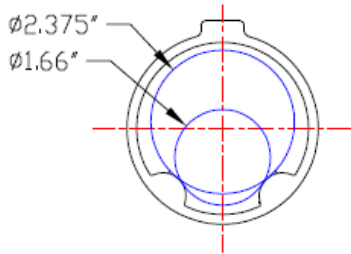
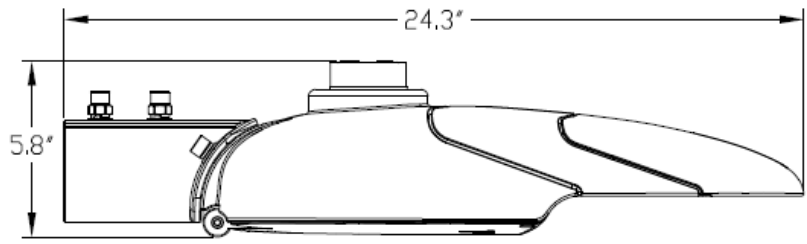
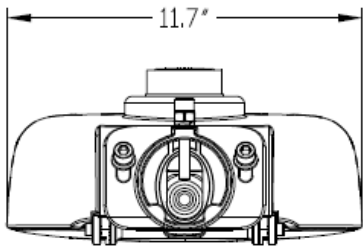

**FEATURES**

